

DENON

DOUBLE CD PLAYER

DN-2500F

OPERATING INSTRUCTIONS



IMPORTANT TO SAFETY

WARNING:

TO PREVENT FIRE OR SHOCK HAZARD, DO NOT EXPOSE THIS APPLIANCE TO RAIN OR MOISTURE.

CAUTION:

1. Handle the power supply cord carefully

Do not damage or deform the power supply cord. If it is damaged or deformed, it may cause electric shock or malfunction when used. When removing from wall outlet, be sure to remove by holding the plug attachment and not by pulling the cord.

2. Do not open the top cover

In order to prevent electric shock, do not open the top cover. If problems occur, contact your DENON dealer.

3. Do not place anything inside

Do not place metal objects or spill liquid inside the CD player. Electric shock or malfunction may result.

Please, record and retain the Model name and serial number of your set shown on the rating label.

Model No. DN-2500F

Serial No. _____



CAUTION
RISK OF ELECTRIC SHOCK
DO NOT OPEN



CAUTION: TO REDUCE THE RISK OF ELECTRIC SHOCK, DO NOT REMOVE COVER (OR BACK). NO USER-SERVICEABLE PARTS INSIDE. REFER SERVICING TO QUALIFIED SERVICE PERSONNEL.



The lightning flash with arrowhead symbol, within an equilateral triangle, is intended to alert the user to the presence of uninsulated "dangerous voltage" within the product's enclosure that may be of sufficient magnitude to constitute a risk of electric shock to persons.



The exclamation point within an equilateral triangle is intended to alert the user to the presence of important operating and maintenance (servicing) instructions in the literature accompanying the appliance.

NOTE:

This CD player uses the semiconductor laser. To allow you to enjoy music at a stable operation, it is recommended to use this in a room of 5 °C (41 °F) –35 °C (95 °F).

• FOR U.S.A. & CANADA MODEL ONLY

CAUTION

TO PREVENT ELECTRIC SHOCK DO NOT USE THIS (POLARIZED) PLUG WITH AN EXTENSION CORD, RECEPTACLE OR OTHER OUTLET UNLESS THE BLADES CAN BE FULLY INSERTED TO PREVENT BLADE EXPOSURE.

LABELS (for U.S.A. model only)

CERTIFICATION

THIS PRODUCT COMPLIES WITH DHHS RULES 21 CFR SUBCHAPTER J APPLICABLE AT DATE OF MANUFACTURE.

CAUTION:

USE OF CONTROLS OR ADJUSTMENTS OR PERFORMANCE OF PROCEDURES OTHER THAN THOSE SPECIFIED HEREIN MAY RESULT IN HAZARDOUS RADIATION EXPOSURE.

THE COMPACT DISC PLAYER SHOULD NOT BE ADJUSTED OR REPAIRED BY ANYONE EXCEPT PROPERLY QUALIFIED SERVICE PERSONNEL.

This device complies with Part 15 of the FCC Rules. Operation is subject to the following two conditions : (1) This device may not cause harmful interference, and (2) this device must accept any interference received, including interference that may cause undesired operation.

This Class B digital apparatus meets all requirements of the Canadian Interference-Causing Equipment Regulations.

Cet appareil numérique de la classe B respecte toutes les exigences du Règlement sur le matériel brouilleur du Canada.

CLASS 1 LASER PRODUCT
LUOKAN 1 LASERLAITE
KLASS 1 LASERAPPARAT

"CLASS 1
LASER PRODUCT"

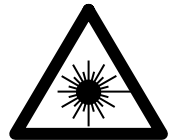

ADVARSEL: USYNLIG LASERSTRÅLING VED ÅBNING, NÅR SIKKERHEDSAFBYRDERE ER UDE AF FUNKTION. UNDGÅ UDSAETTELSE FOR STRÅLING.

VAROITUS! LAITTEEN KÄYTTÄMINEN MUULLA KUIN TÄSSÄ KÄYTTÖOHJEESSA MAINITULLA TAVALLA SAATTAA ALTISTAA KÄYTTÄJÄN TURVALLISUUSLUOKAN 1 YLITTÄVÄLLE NÄKYMÄMTTÖMÄLLE LASERSÄTEILYLLE.

VARNING- OM APPARATEN ANVÄNDS PÅ ANNAT SÄTT ÄN I DENNA BRUKSANVISNING SPECIFICERATS, KAN ANVÄNDAREN UTSÄTTAS FÖR OSYNLIG LASERSTRÅLNING SOM ÖVERSKRIDER GRÄNSEN FÖR LASERKLASS 1.

• POUR LES MODELES AMERICAINS ET CANADIENS UNIQUEMENT

ATTENTION

POUR PREVENIR LES CHOCS ELECTRIQUES NE PAS UTILISER CETTE FICHE POLARISEE AVEC UN PROLONGATEUR UNE PRISE DE COURANT OU UNE AUTRE SORTIE DE COURANT, SAUF SI LES LAMES PEUVENT ETRE INSEREES A FOND SANS EN LAISSER AUCUNE PARTIE A DECOUVERT.

SAFETY INSTRUCTIONS

1. Read Instructions – All the safety and operating instructions should be read before the appliance is operated.
2. Retain Instructions – The safety and operating instructions should be retained for future reference.
3. Heed Warning – All warnings on the appliance and in the operating instructions should be adhered to.
4. Following Instructions – All operating and use instructions should be followed.
5. Water and Moisture – The appliance should not be used near water – for example, near a bathtub, washbowl, kitchen sink, laundry tub, in a wet basement, or near a swimming pool, and the like.
6. Carts and Stands – The appliance should be used only with a cart or stand that is recommended by the manufacturer.
- 6A. An appliance and cart combination should be moved with care. Quick stops, excessive force, and uneven surfaces may cause the appliance and cart combination to overturn.
7. Wall or Ceiling Mounting – The appliance should be mounted to a wall or ceiling only as recommended by the manufacturer.
8. Ventilation – The appliance should be situated so that its location or position does not interfere with its proper ventilation. For example, the appliance should not be situated on a bed, sofa, rug, or similar surface that may block the ventilation openings; or, placed in a built-in installation, such as a bookcase or cabinet that may impede the flow of air through the ventilation openings.
9. Heat – The appliance should be situated away from heat sources such as radiators, heat registers, stoves, or other appliances (including amplifiers) that produce heat.
10. Power Sources – The appliance should be connected to a power supply only of the type described in the operating instructions or as marked on the appliance.
11. Grounding or Polarization – Precautions should be taken so that the grounding or polarization means of an appliance is not defeated.



12. Power-Cord Protection – Power-supply cords should be routed so that they are not likely to be walked on or pinched by items placed upon or against them, paying particular attention to cords at plugs, convenience receptacles, and the point where they exit from the appliance.
14. Cleaning – The appliance should be cleaned only as recommended by the manufacturer.
15. Power Lines – An outdoor antenna should be located away from power lines.
16. Outdoor Antenna Grounding – If an outside antenna is connected to the receiver, be sure the antenna system is grounded so as to provide some protection against voltage surges and built-up static charges. Article 810 of the National Electrical Code, ANSI/NFPA 70, provides information with regard to proper grounding of the mast and supporting structure, grounding of the lead-in wire to an antenna-discharge unit, size of grounding conductors, location of antenna-discharge unit, connection to grounding electrodes, and requirements for the grounding electrode. See Figure A.
17. Nonuse Periods – The power cord of the appliance should be unplugged from the outlet when left unused for a long period of time.
18. Object and Liquid Entry – Care should be taken so that objects do not fall and liquids are not spilled into the enclosure through openings.
19. Damage Requiring Service – The appliance should be serviced by qualified service personnel when:
 - A. The power-supply cord or the plug has been damaged; or
 - B. Objects have fallen, or liquid has been spilled into the appliance; or
 - C. The appliance has been exposed to rain; or
 - D. The appliance does not appear to operate normally or exhibits a marked change in performance; or
 - E. The appliance has been dropped, or the enclosure damaged.
20. Servicing – The user should not attempt to service the appliance beyond that described in the operating instructions. All other servicing should be referred to qualified service personnel.

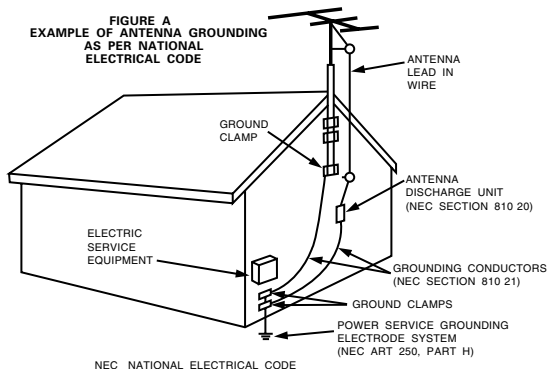

**NOTE ON USE / HINWEISE ZUM GEBRAUCH / OBSERVATIONS RELATIVES A L'UTILISATION
NOTAS SOBRE EL USO / ALVORENS TE GEBRUIKEN / OBSERVERA**

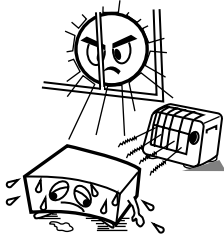

- Avoid high temperatures. Allow for sufficient heat dispersion when installed on a rack.
- Vermeiden Sie hohe Temperaturen. Beachten Sie, daß eine ausreichend Luftzirkulation gewährleistet wird, wenn das Gerät auf ein Regal gestellt wird.
- Eviter des températures élevées. Tenir compte d'une dispersion de chaleur suffisante lors de l'installation sur une étagère.
- Evite altas temperaturas. Permite la suficiente dispersión del calor cuando está instalado en la consola.
- Vermijd hoge temperaturen. Zorg voor een degelijk hitteafvoer indien het apparaat op een rek wordt geplaatst.
- Undvik höga temperaturer. Se till att det finns möjlighet till god värmeavledning vid monteringen i ett rack.

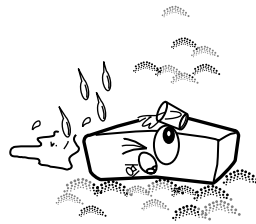

- Keep the set free from moisture, water, and dust.
- Halten Sie das Gerät von Feuchtigkeit, Wasser und Staub fern.
- Protéger l'appareil contre l'humidité, l'eau et la poussière.
- Mantenga el equipo libre de humedad, agua y polvo.
- Laat geen vochtigheid, water of stof in het apparaat binnendringen.
- Utsätt inte apparaten för fukt, vatten och damm.

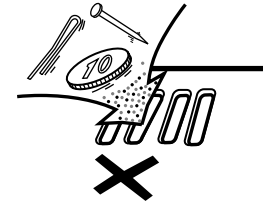

- Do not let foreign objects in the set.
- Keine fremden Gegenstände in das Gerät kommen lassen.
- Ne pas laisser des objets étrangers dans l'appareil.
- No deje objetos extraños dentro del equipo.
- Laat geen vreemde voorwerpen in dit apparaat vallen.
- Se till att främmande föremål inte tränger in i apparaten.

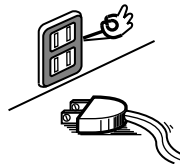

- Unplug the power cord when not using the set for long periods of time.
- Wenn das Gerät eine längere Zeit nicht verwendet werden soll, trennen Sie das Netzkabel vom Netzstecker.
- Débrancher le cordon d'alimentation lorsque l'appareil n'est pas utilisé pendant de longues périodes.
- Desconecte el cordón de energía cuando no utilice el equipo por mucho tiempo.
- Neem altijd het netsnoer uit het stopcontact wanneer het apparaat gedurende een lange periode niet wordt gebruikt.
- Koppla ur nätkabeln om apparaten inte kommer att användas i lång tid.

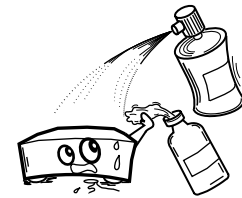

- Do not let insecticides, benzene, and thinner come in contact with the set.
- Lassen Sie das Gerät nicht mit Insektiziden, Benzin oder Verdünnungsmitteln in Berührung kommen.
- Ne pas mettre en contact des insecticides, du benzène et un diluant avec l'appareil.
- No permita el contacto de insecticidas, gasolina y diluyentes con el equipo.
- Laat geen insectenverdelgende middelen, benzine of verfverdunder met dit apparaat in contact komen.
- Se till att inte insektsmedel på spraybruk, bensen och thinner kommer i kontakt med apparatens hölje.

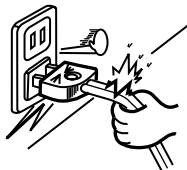

- Handle the power cord carefully. Hold the plug when unplugging the cord.
- Gehen Sie vorsichtig mit dem Netzkabel um. Halten Sie das Kabel am Stecker, wenn Sie den Stecker herausziehen.
- Manipuler le cordon d'alimentation avec précaution. Tenir la prise lors du débranchement du cordon.
- Maneje el cordón de energía con cuidado. Sostenga el enchufe cuando desconecte el cordón de energía.
- Hanteer het netsnoer voorzichtig. Houd het snoer bij de stekker vast wanneer deze moet worden aan- of losgekoppeld.
- Hantera nätkabeln varsamt. Håll i kabeln när den kopplas från el-uttaget.

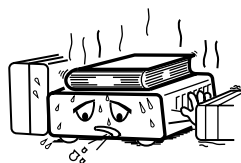

* (For sets with ventilation holes)

- Do not obstruct the ventilation holes.
- Die Belüftungsöffnungen dürfen nicht verdeckt werden.
- Ne pas obstruer les trous d'aération.
- No obstruya los orificios de ventilación.
- De ventilatieopeningen mogen niet worden beblokkeerd.
- Täpp inte till ventilationsöppningarna.

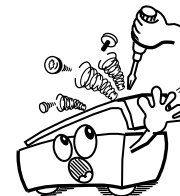

- Never disassemble or modify the set in any way.
- Versuchen Sie niemals das Gerät auseinander zu nehmen oder auf jegliche Art zu verändern.
- Ne jamais démonter ou modifier l'appareil d'une manière ou d'une autre.
- Nunca desarme o modifique el equipo de ninguna manera.
- Nooit dit apparaat demonteren of op andere wijze modifieren.
- Ta inte isär apparaten och försök inte bygga om den.

RC-44

CONTROL UNIT / STEUERUNGSTEIL / TELECOMMANDE / UNIDAD DE CONTROL / KONTROLLDEL / 控制機組

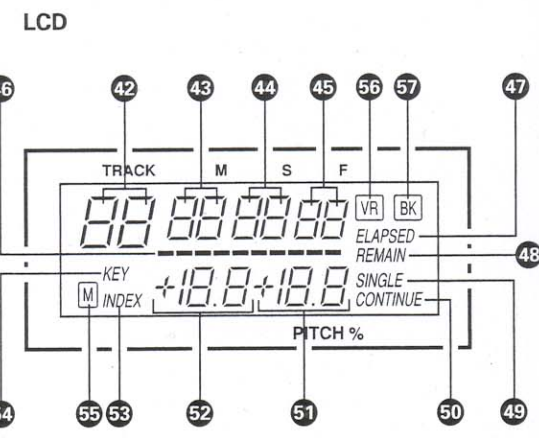
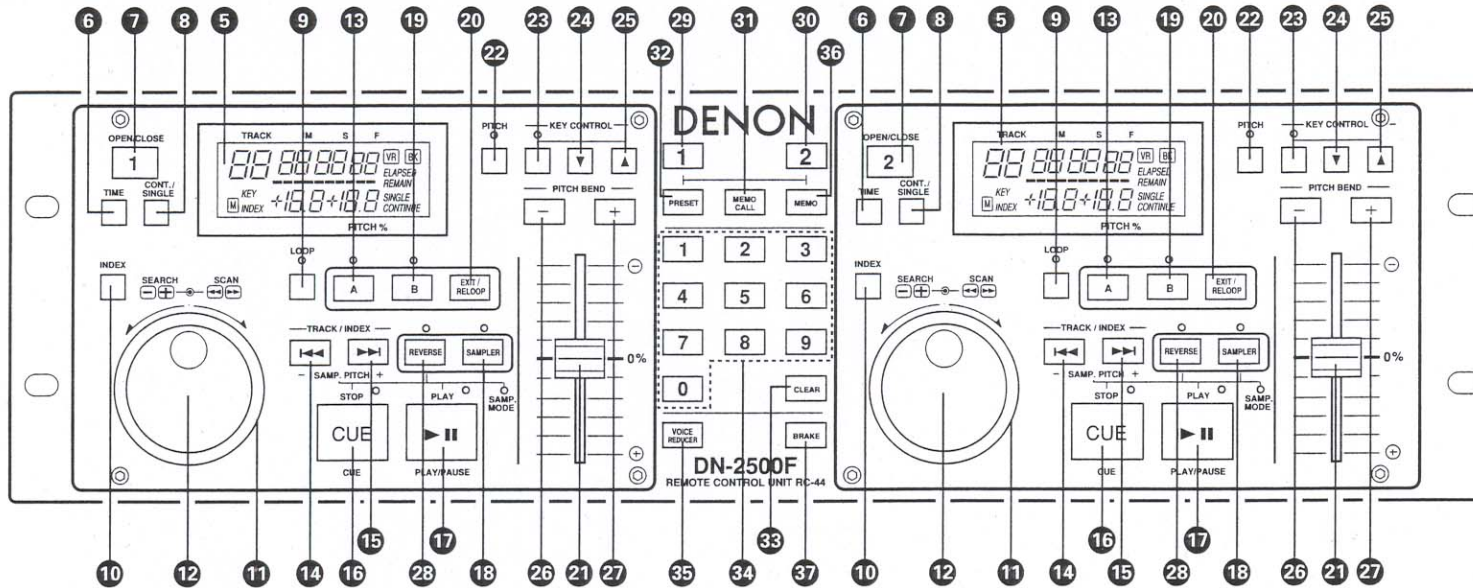
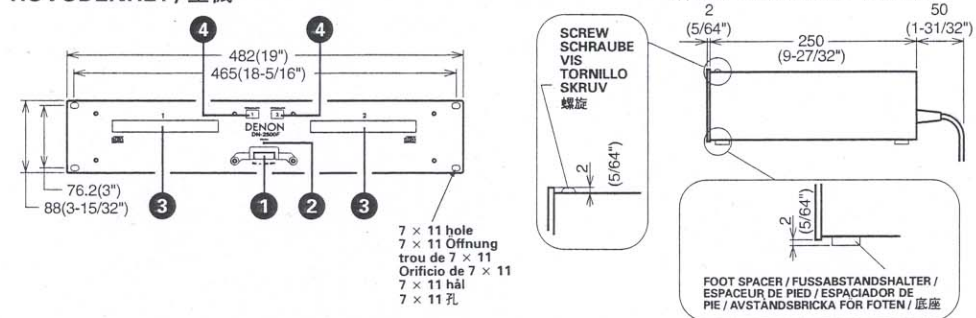

Figure 3 / Abbildung 3 / Figure 3 / Figura 3 / Figur 3 / 圖3

Figure 1 / Abbildung 1 / Figure 1 / Figura 1 / Figur 1 / 圖1

DN-2500F

MAIN UNIT / HAUPTTEIL / UNITE PRINCIPALE / UNIDAD PRINCIPAL / HUVUDENHET / 主機



REAR PANEL / RÜCKSEITE / PANNEAU ARRIERE / PANEL TRASERO / BAKPANEL / 背面

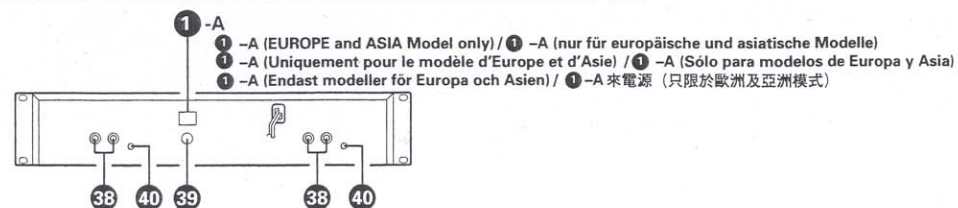
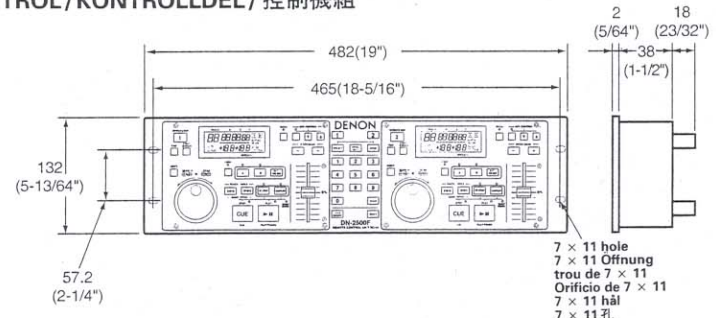

Figure 2 / Abbildung 2 / Figure 2 / Figura 2 / Figur 2 / 圖2

RC-44

CONTROL UNIT / STEUERUNGSTEIL / TELECOMMANDE / UNIDAD DE CONTROL / KONTROLLDEL / 控制機組



REAR PANEL / RÜCKSEITE / PANNEAU ARRIERE / PANEL TRASERO / BAKPANEL / 背面

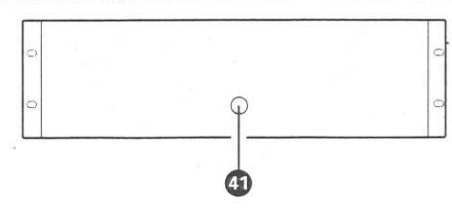

Figure 4 / Abbildung 4 / Figure 4 / Figura 4 / Figur 4 / 圖4

MAIN FEATURES

The DN-2500F is a double CD player which incorporates all of the popular functions from the DN-2000FMKII and adds additional features for more advanced DJ mixing and remixing.

- (1) The DN-2500F can be easily mounted on a standard 19-inch rack.
- (2) The player unit and control unit are connected by a single cord, providing installation freedom.
- (3) Playback begins immediately when the PLAY button is pressed. **(Instant Start)**
- (4) Pitch is adjustable using a long-throw slider, providing an analog feel.
- (5) The pitch can be changed temporarily based on the already adjusted pitch. **(Pitch Bend)**
- (6) The point at which the sound actually starts is searched for automatically when a track is selected, eliminating troublesome searching operations. **(Cue to Music)**
- (7) Searching is possible in units of single frames (1 /75 of a second), the minimum time unit on CDs, for maximum precision.

In addition to the above functions (all provided on the DN-2000FMKII), the DN-2500F also includes the following functions:

- (8) The range of the pitch control slider is selectable between $\pm 4\%$, $\pm 8\%$ and $\pm 16\%$.
- (9) A Sampler function is included which provides over eight seconds of stereo sampling per side. Sample playback is triggered from the PLAY/PAUSE button while in sample mode. **(Sampler)**
- (10) Familiar Jog/Shuttle dial controls allow fast and accurate searching of CD's. **(Jog Shuttle)**
- (11) Key control function for adjusting the playback key. **(Key Control)**
- (12) Voice Reducer function for reducing the sound of the vocals. **(Voice Reducer)**
- (13) Brake function for gradually slowing the playback speed before stopping. **(Brake)**
- (14) Memory function for recording and recalling disc identification data, cue point data, etc. **(Custom Setting Memory)**
- (15) Direct Search function for directly accessing a specific point on a disc or a specific index number using the number buttons. **(Direct Search)**
- (16) Preset function for setting functions according to the usage purpose.
- (17) Fader input. **(Mini Jack)**
- (18) Servo Auto Stop function for Spindle Motor

NOTE:

This CD player uses the semiconductor laser. To allow you to enjoy music at a stable operation, it is recommended to use this in a room of 5°C (41°F)-35°C (95°F).

CAUTION: (U.S.A. and Canada model only)

Whenever the power switch is in the OFF state, the apparatus is still connected on AC line voltage.

Please be sure to unplug the cord when you leave home for, say, a vacation.

Be sure turn on POWER switch after a Remote cable of RC-44 is connected to the Player unit, otherwise, the apparatus may not work correctly.

CAUTION: (Europe and Asia model only)

To use the player, turn on the main power switch on the rear panel.

Please be sure to turn off the main power switch when you leave home for, say, a vacation.

DECLARATION OF CONFORMITY

We declare under our sole responsibility that this product, to which this declaration relates, is in conformity with the following standards:

EN60065, EN55013, EN55020, EN60555-2 and EN60555-3.

Following the provisions of 73/23/EEC, 89/336/EEC and 93/68/EEC Directive.

CONTENTS

1	PREPARATIONS	9	6	SAMPLER	19--21
	(1) Checking the Contents	9		(1) Recording samples	19
	(2) Installing the Units	9		(2) Playing the sample	20
	(3) Connections	9		(3) Stopping the sample	20
2	NAMES AND FUNCTIONS	10--12		(4) Changing the sample's pitch	20
	(1) DN-2500F (Main Unit) Front Panel	10		(5) Setting the normal disc playback mode after recording a sample	20
	(2) RC-44 (Control Unit) Front Panel	10, 11		(6) Playing the sample in reverse	21
	(3) DN-2500F (Main Unit) Rear Panel	11		(7) Playing the sample in a loop	21
	(4) RC-44 (Control Unit) Rear Panel	11		(8) This clears the recorded sample	21
	(5) LCD	11, 12	7	KEY CONTROL	21,22
3	BASIC OPERATIONS	12--16	8	VOICE REDUCER	22
	(1) Opening and Closing the Disc Holder and Loading Discs	12	9	BRAKE	23
	(2) Selecting Tracks or INDEX	13	10	CUSTOM SETTING MEMORY	23--26
	(3) Starting Playback	13		(1) Storing data in the memory	23
	(4) Stopping Playback	14		(2) Overwriting previous data (This is only possible if 200 sets of data are already stored.)	24
	(5) Pausing	14		(3) Recalling data	25
	(6) Cueing	15		(4) Clearing data	25,26
	(7) Searching	15	11	DIRECT SEARCH	26, 27
	(8) Scanning	16		(1) Direct track and time search	26,27
4	MATCHING THE BEATS PER MINUTE (BPM) ..	16,17		(2) Direct index search	27
	(1) Pitch Slider	16	12	PRESETTINGS	27-29
	(2) Pitch Bending	17		(1) Changing the preset data	27, 28
5	SEAMLESS LOOP	17--19		(2) Table of Preset Functions	29
	(1) Starting seamless loop playback	17, 18	13	FADER INPUT	29
	(2) Leaving the seamless loop mode temporarily ..	18	14	BEFORE SWITCHING OFF THE POWER	30
	(3) Replaying a seamless loop	18	15	COMPACT DISCS	30
	(4) Switching from seamless loop playback to normal disc playback	18	16	SPECIFICATIONS	31
	(5) Canceling the seamless loop settings	19			

1 PREPARATIONS

(1) Checking the Contents

Check that the carton contains the following items:

- ① DN-2500F (main unit) 1
- ② RC-44 (control unit) 1
- ③ Operating instructions (this booklet) 1
- ④ Pair of RCA pin cords 2
- ⑤ Control cord (3-meter, 9.8 feet) 1

(2) Installing the Units

Mount the units onto your console or rack with 19" EIA rack rails.

CAUTION:

The DN-2500F will work normally when the main unit is mounted with the front panel within 20 degrees of the vertical plane. If the unit is tilted excessively, discs may not load or unload properly. (Figure 5)

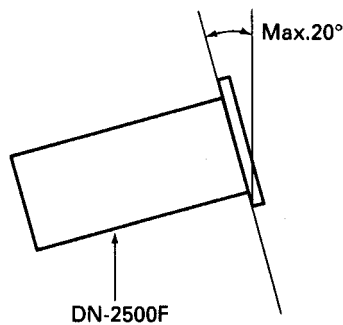

Figure 5

(3) Connections

- ① Turn off the POWER switch.
- ② Connect the RCA pin cords to the inputs on your mixer.
- ③ Connect the control cord to the REMOTE connector on the RC-44.

CAUTION:





Be sure to use the supplied control cord. Using another type of cable may result in damage.
Be sure the power is off when connecting the control cord. Otherwise the units may not work properly.

2 NAMES AND FUNCTIONS

Below is a description of the functions of the controls listed on Pages 4 and 5.

(1) DN-2500F (Main Unit) Front Panel

- 1 2 POWER (Power Switch and Indicator)
When the POWER switch is pressed, the power turns on and the POWER indicator lights.
 - 3 Disc Holders
Place the discs in these holders. Press the OPEN/CLOSE buttons to open and close the disc holders.
 - 4 OPEN/ CLOSE Buttons
Press these to open and close the disc holders. The control unit also includes OPEN/CLOSE buttons. The disc holders cannot be opened during playback, so playback must be stopped before pressing these buttons.
- ### (2) RC-44 (Control Unit) Front Panel
- 5 LCD
These liquid crystal displays (LCDs) indicate the current track numbers, minutes, seconds, frames and memory location numbers.
 - 6 TIME Buttons
These buttons switch the time display between elapsed time and remaining time. The selected mode is indicated by the ELAPSED and REMAIN indicators on the LCD.
 - 7 OPEN/ CLOSE Buttons
Press these to open and close the disc holders. The main unit also includes OPEN/CLOSE buttons. The disc holders cannot be opened during playback, so playback must be stopped before pressing these buttons.
 - 8 CONT. / SINGLE Buttons
Press these to switch between the single and continuous play modes. The selected mode is indicated by the SINGLE and CONTINUE indicators on the LCD.
 - 9 LOOP Buttons
Press these buttons to start loop mode. The LOOP LED is lit solid during loop playback.
 - 10 INDEX Button
Press this button to turn the index mode on and off. The "INDEX" indicator lights when the index mode is turned on.
 - 11 Shuttle Dials
Use these dials to select the scanning direction and speed. The disc is scanned in the forward direction when the shuttle dial is turned clockwise from the neutral position, and in the reverse direction when the shuttle dial is turned counterclockwise. The scanning speed increases as the wheel is turned further.
 - 12 Jog Dials
When these dials are turned during the search operation, the point at which the sound is being produced moves by a number of frames corresponding to the number of clicks.

- 13 A Buttons
Use these buttons to set the starting point for loop playback.
- 14 15 TRACK/ INDEX SAMP. PITCH -  and TRACK/ INDEX SAMP PITCH +  Buttons
Use these buttons to select the track, the index, to be played. Also selects the sampler pitch during sample playback.
- 16 CUE Buttons
Press the CUE buttons during playback to return to the position at which playback started. The player is ready to play when the CUE LED stops flashing, remaining lit.
- 17 PLAY/PAUSE  Buttons
Use these buttons to start playback. Press once to start playback, once again to set the pause mode, and once more to resume playback.
- 18 SAMPLER Buttons
Press these buttons to start recording the sample. Press the PLAY/PAUSE button after recording to set the sample play mode. These are also used to switch between the disc play and sample play mode.
- 19 B Buttons
Use these buttons to set the end point for loop playback.
- 20 EXIT/ RELOOP Button
Press these buttons during loop playback to stop loop playback and continue normal playback past the B point (exit), or to return to loop playback for a loop which was previously exited (reloop).
- 21 Pitch Sliders
Use these sliders to adjust the BPM. Slide up to decrease the BPM, down to increase the BPM.
- 22 PITCH Buttons
Use these buttons to enable or disable pitch adjustment using the pitch sliders. Pitch adjustment with the pitch slider is enabled when the PITCH LED is lit.
- 23 KEY CONTROL Buttons
When these buttons are pressed, the key control mode is turned on and the key can be adjusted with the  and  buttons. When pressed again, the key adjust mode is turned on and the key remains the same even if the pitch is changed. (KEY ADJUST)
Press the buttons again to return to the normal mode.

- 24** ▼ Buttons
When the key control mode is on, press these buttons to lower the key.
- 25** ▲ Buttons
When the key control mode is on, press these buttons to raise the key.
- 26** **27** PITCH BEND- and PITCH BEND+ Buttons
The pitch changes temporarily while these buttons are pressed. Release the buttons to return to the original BPM.
- 28** REVERSE Buttons
Press these buttons to turn the sampler's reverse playback mode on and off.
After pressing the REVERSE button, the direction of playback does not change until the PLAY/PAUSE button is pressed.
The REVERSE LED lights when the reverse playback mode is on.
- 29** **30** 1 and 2 Buttons
Use these buttons to select which player the number buttons will function for.
- 31** MEMO CALL Button
When the CD "1" or "2" button is pressed while pressing this button, the data stored in the memory is called out and set.
- 32** PRESET Button
Press the CD "1" or "2" button while pressing this button to set CD 1 or 2 to the preset mode.
Press this button to set the preset data.
Press the button again while pressing the CD "1" or "2" button to turn the preset mode off.
- 33** CLEAR Button
Press this button to clear the data which was input using the number buttons.
- 34** 0 ---9 Buttons (Number Buttons)
Use these buttons to input track numbers, times (minutes and seconds), and select the PRESET items.
- 35** VOICE REDUCER Button
When the CD "1" or "2" button is pressed while pressing this button, CD 1 or 2 is set to the voice reducer mode, and the level of the vocals in the music is reduced. (The "VR" indicator lights.)
Press the CD "1" or "2" button again while pressing the button to return to the normal playback mode. (The "VR" indicator turns off.)
- 36** MEMO Button (Custom Setting Memory)
Press the CD "1" or "2" button while pressing this button to store the CD 1 or 2 settings (disc data, cue point, loop start point, loop end point, pitch). (The "M" indicator lights.)
- 37** BRAKE Button
When the CD "1" or "2" button is pressed while pressing this button, CD 1 or 2 is set to the brake mode and brake playback is enabled. (The "BK" indicator lights.)
Press the CD "1" or "2" button again while pressing the button to return to the normal playback mode. (The "BK" indicator turns off.)
- (3) DN-2500F (Main Unit) Rear Panel**
- 38** LINE OUT 1 and 2
The audio signals from each player are output from these jacks.
- 39** REMOTE
Connect this connector to the RC-44 control unit using the included control cord.
- 40** FADER IN
Use this when using the unit with a console fader. (Mini Jack)
- 1-A** MAIN POWER (Europe and Asia Model only)
Make sure to switch on.
- (4) RC-44 (Control Unit) Rear Panel**
- 41** Control Connector
Connect this connector to the REMOTE connector on the DN-2500F (main unit) using the included control cord.
- (5) LCD**
- 42** **43** **44** **45** TRACK, MINUTE, SECOND and FRAME Displays
These displays indicate information on the current position and time.
- 46** BAR Indicator
These ten indicators provide a visual display of the approximate position of the pickup within the current track.
- 47** ELAPSED Indicators
These indicate that the time shown on the display is the elapsed time.
- REMAIN Indicators
These indicate that the time shown on the display is the remaining time.
- 49** SINGLE Indicators
When these indicators are lit, playback will stop at the end of the track.
- 50** CONTINUE Indicators
When these indicators are lit, playback will continue until the end of the disc.

- 51 Pitch Display**
This indicates the playback speed (pitch). (-16.0 to +16.0)
- 52 Key/ Index Display**
This indicates the key when in the key control mode. (-16.0 to +16.0)
This also indicates the track's index number. (01 to 99)
- 53 Index Indicator (INDEX)**
This lights when the track's index number is displayed.
- 54 Key Indicator (KEY)**
This lights when the key is displayed.

- 55 Custom Setting Memory Indicator (M)**
This lights when there is data stored in the memory.
- 56 Voice Reducer Indicator (VR)**
This lights when the voice reducer mode is on.
- 57 Brake Indicator (BK)**
This lights when brake playback is enabled.

3 BASIC OPERATIONS

(1) Opening and Closing the Disc Holder and Loading Discs

① Opening and closing the disc holder

This operation only works when the power is on.

Press the OPEN /CLOSE button to open or close the disc holder. OPEN /CLOSE buttons are provided on both the main unit and control unit (RC-44).

The disc holders cannot be opened during playback to prevent playback from being interrupted if the OPEN/CLOSE button is pressed accidentally. Stop playback, then press the OPEN/CLOSE button.

② Loading discs

Hold the disc by the edges and place it in the disc tray. Do not touch the signal surface (the glossy side).

When using 12cm discs, place the disc in the outer tray guides (Figure 6), and when using 8cm discs, place them securely in the inner guides (Figure 7).

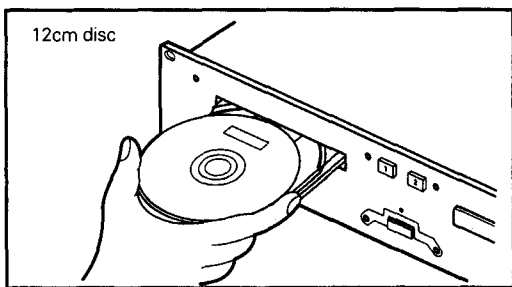

Figure 6

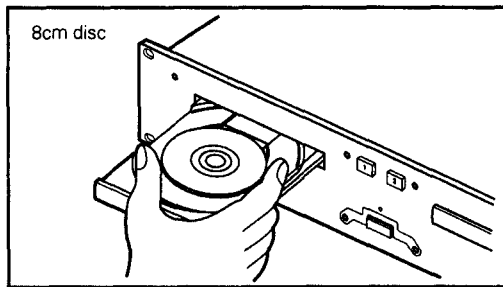

Figure 7

CAUTION:

Do not place any foreign objects in the disc tray, and do not place more than one disc in the disc tray at a time. Doing so may result in malfunction.

Do not push the disc tray in manually when the power is off, as this may result in malfunction and damage the player.

(2) Selecting Tracks or INDEX

- Press the TRACK buttons once to move to the next or preceding track.
- Hold down the TRACK buttons to change tracks continuously at a higher speed.
- When a new track is selected during playback, playback begins as soon as the search operation is completed.
- Tracks can also be selected while the disc holder is open. The selected track is searched for when the disc holder is closed. If the TRACK >>| button is pressed while on the last track, the first track is selected. Likewise, if the TRACK >>| button is pressed while on the first track, the last track is selected.

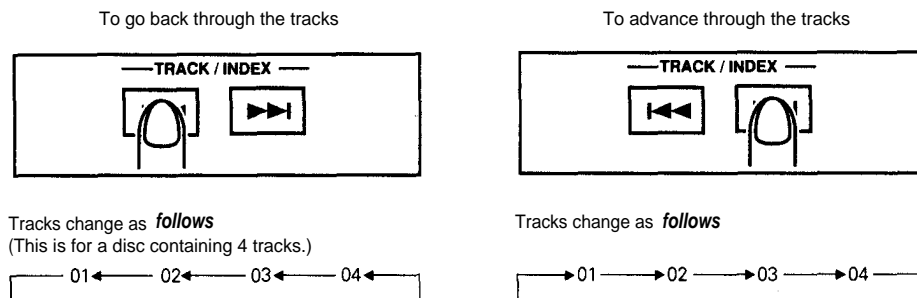

Figure 8

- When a track is selected, the DN-2500F automatically cues to the point at which the sound begins, skipping silent sections at the beginning of tracks. (Cue to Music) Level of cue point can be selected with preset item 4.
- When the INDEX button is pressed and the index search mode is set, use the INDEX >>| and |<< buttons for the index search operation.

(3) Starting Playback

- Press the PLAY/PAUSE button during pause or cue mode to start playback.
- Playback begins immediately when the PLAY button is pressed. (Instant Start)
- The PLAY/PAUSE LED lights when playback starts.
- The point at which playback starts is automatically stored in the memory as the cue point. When the CUE button is pressed, the pickup then returns to the cue point (the point at which playback started). (Back Cue)

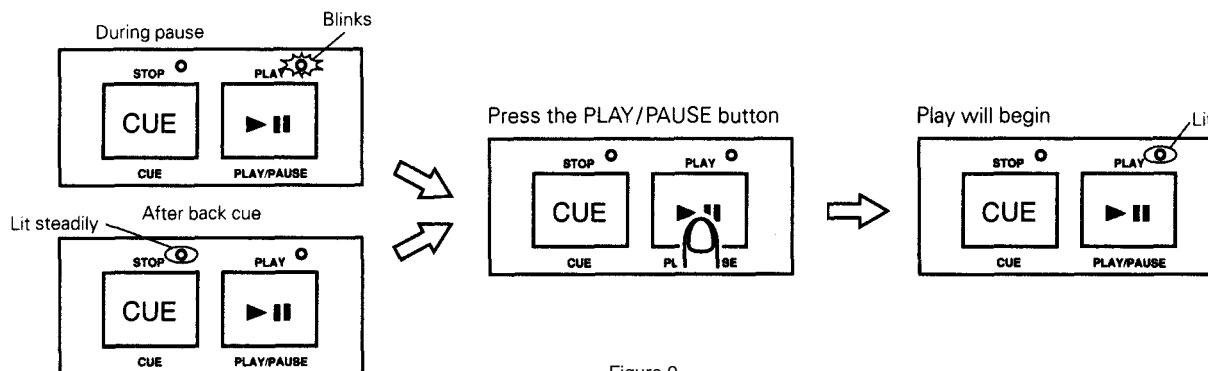

Figure 9

- The play mode can be selected by pressing the CONT./SINGLE button.
- When the SINGLE indicator is lit, playback stops automatically at the end of that track, and the disc is cued to the playback start position.
- When the CONTINUE indicator is lit, playback continues until the end of that disc. When playback is finished, the disc is cued to the playback start position.

(4) Stopping Playback

There are two ways to stop playback.

- ① Press the PLAY/PAUSE button during playback to pause at that point.
- ② Press the CUE button during playback to return to cue mode at the position at which playback started. (Back Cue)

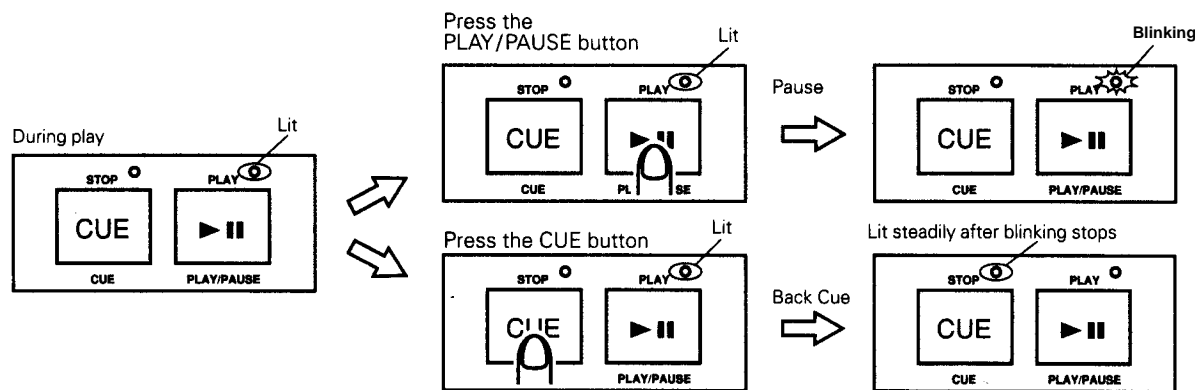

Figure 10

(5) Pausing

Press the PLAY/PAUSE button to switch between play and pause mode.

The PLAY/PAUSE LED blinks when the pause mode is set.

Figure 11 shows the relationship between the play and pause.

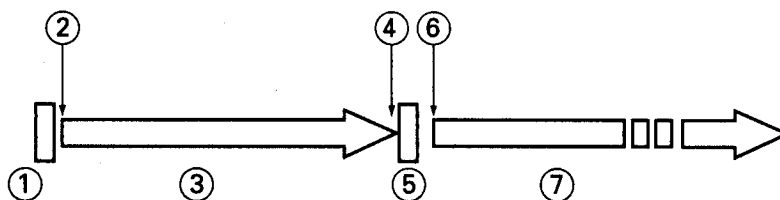

- ① The player has completed the cue or pause operation and is waiting for the play start command.
- ② When the PLAY/PAUSE button is pressed, playback starts and the cue point is stored in the memory.
- ③ Playing
- ④ The pause mode is set when the PLAY/PAUSE button is pressed again.
- ⑤ Pausing
- ⑥ Playback resumes when the PLAY/PAUSE button is pressed again.
- ⑦ Playing

Figure 11

(6) Cueing

- "Cueing" is the action of moving to a specified point (the cue point) and waiting for playback to begin (cue mode). When the PLAY/PAUSE button is pressed after cueing, playback starts immediately. (Instant Start)
- When the track search operation is completed after pressing the TRACK buttons, the player locates the position at which the sound starts and automatically cues there. (Cue to Music)
- If the CUE button is pressed during the search operation with the jog dial or the scanning operation with the shuttle dial, the point at which the button is pressed is set as the cue point and cueing starts.
- Figure 12 shows the relationship between the play and back cue operations.

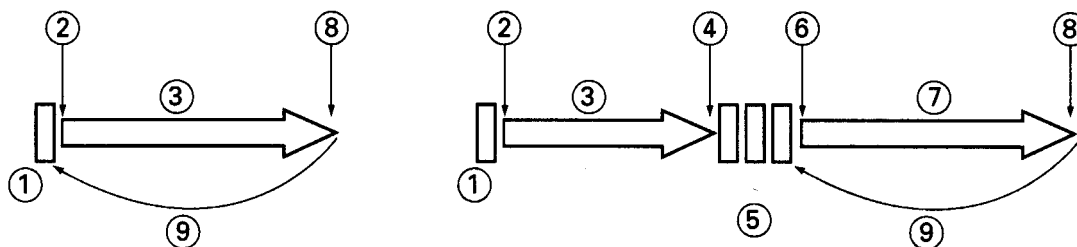

(A) Play and cue

- ① The player has completed the cue or pause operation and is waiting for the play start command.
- ② When the PLAY/PAUSE button is pressed, playback starts and the cue point is stored in the memory.
- ③ Playing
- ④ The pause mode is set when the PLAY/PAUSE button is pressed again.
- ⑤ Pausing
- ⑥ When the PLAY/PAUSE button is pressed again, playback resumes and the new cue point is stored in the memory.
- ⑦ Playing
- ⑧ Press the CUE button.
- ⑨ The pickup returns to the cue point. (Back Cue)

Figure 12

(7) Searching

- Searching is the function which allows you to continuously monitor a certain section of the disc and manually change the playback position in small increments. Searching is used to set playback start points and loop points with precision.
- Turn the jog dial while in the play, pause or cue mode to begin searching. The sound for one revolution of the disc is output repeatedly. The point at which the sound starts (the search point) is indicated on the LCD.
- When the jog dial is turned, the point from which the sound is output moves a number of frames corresponding to the number of clicks, and the time display on the LCD also changes.
- The search point moves in the forward direction when the jog dial is turned clockwise, in the reverse direction when the jog dial is turned counterclockwise.

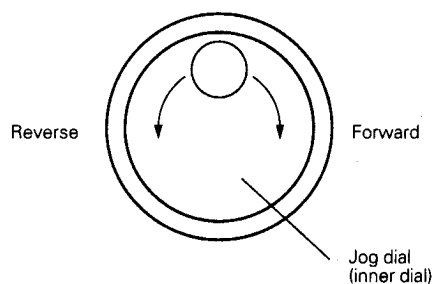

Figure 13

- The search point displayed on the LCD during the search operation is automatically stored in the memory as the cue point.
- If the jog dial is turned while in play mode, playback resumes automatically once the jog dial is released.

(8) Scanning

Scanning allows you to move quickly forward or backward through the CD while monitoring the sound, and is used, for example, to locate a specific section in a song.

Turn the shuttle dial while the player is in the play, pause or cue modes to begin scanning. The disc moves rapidly forward or backward and the sound is output. The current point (scan point) is indicated on the LCD.

The scanning speed depends on how far from the center point the shuttle dial is turned. The more it is turned, the faster the scanning speed.

Turn the shuttle dial clockwise to scan in the forward direction, counterclockwise to scan in the reverse direction.

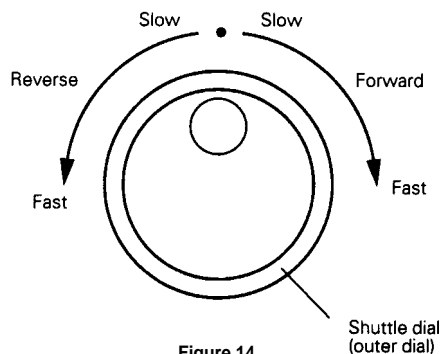

Figure 14

The scanning point indicated on the LCD is automatically stored in the memory as the cue point.

- When the shuttle dial is released during scanning, it returns to the neutral position, scanning stops and the search mode is set. However, if scanning was started from play mode, playback resumes.
- When the dial is turned all the way to the end, the point of playback is skipped approximately one minute, played for about 3 seconds, then skipped again, etc.

4 MATCHING THE BEATS PER MINUTE (BPM)

- With the DN-2500F, there are two ways to adjust the playing speed and match the BPMs of the two CDs:
 - Use the pitch slider to adjust the BPM statically. One of three adjustments ranges can be selected by the Preset Mode.
 - Use the PITCH BEND buttons to change the BPM temporarily. Use this after adjusting the BPM with the pitch slider.

(1) Pitch Slider

- To adjust the BPM by sliding the pitch slider up or down, first press the PITCH button to enable the pitch slider. The PITCH LED will turn on.
- With the pitch slider, the pitch can be adjusted within one of three ranges ($\pm 4\%$, $\pm 8\%$ or $\pm 16\%$). (Can be selected with preset item 3.)
- The BPM decreases when the pitch slider is moved upwards, increases when the pitch slider is moved downwards.

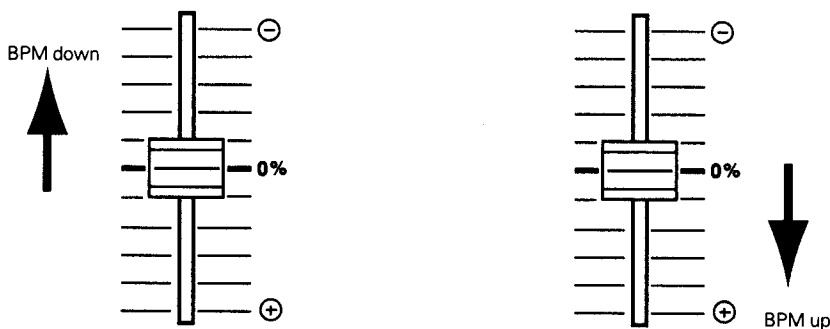
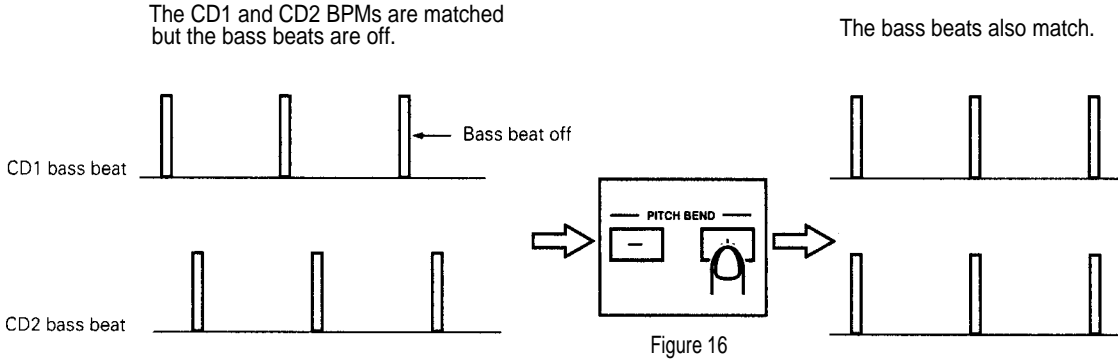

Figure 15

(2) Pitch Bending

The BPM increases or decreases temporarily while the PITCH BEND + or PITCH BEND - button is pressed. The extent to which the PITCH BEND button changes the BPM is proportionate to the amount of time the button is pressed. The longer the button is held down, the greater the percentage of change. The PITCH BEND button changes the BPM within a range of $\pm 12\%$ when the pitch adjustment range is $\pm 4\%$ or $\pm 8\%$, and within a range of $\pm 18\%$ when the pitch adjustment range is $\pm 16\%$. Figure 16 shows an example of how to use the pitch bend function. In this example, both players are playing and the BPM has already been matched with the pitch sliders.



5 SEAMLESS LOOP

The DN-2500F is equipped with a seamless loop function.

NOTE: The seamless loop mode cannot be used at the same time as the sampler mode.

(1) Starting seamless loop playback

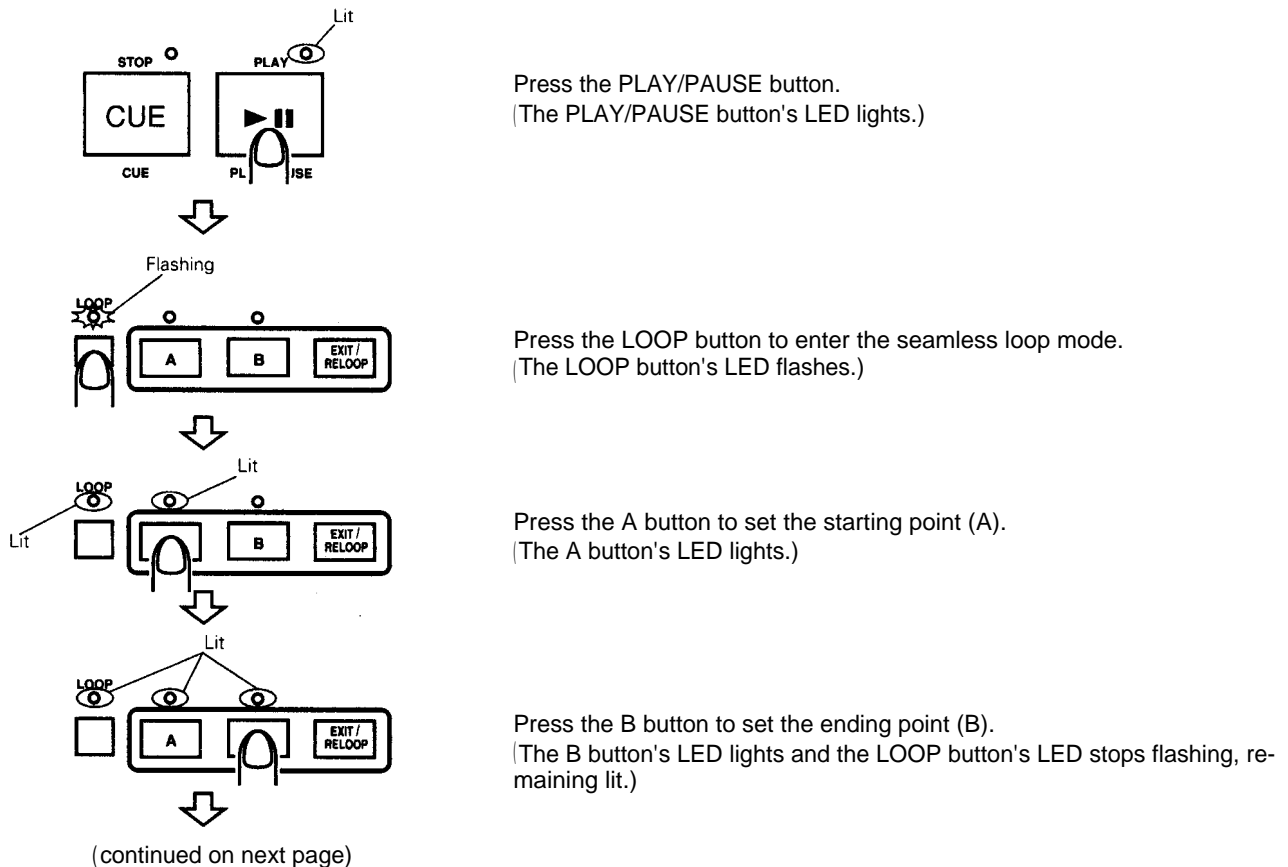

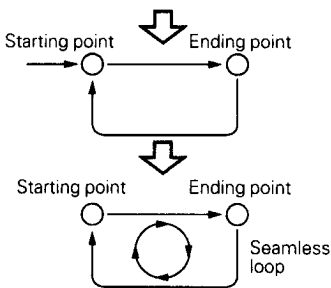

Figure 17

When the ending point (B) is set, playback starts from the starting point (A) with no interruption in the sound.

After this, the section between the starting point (A) and the ending point (B) is played repeatedly with no interruption in the sound.

Alternative way to set the seamless loop starting point (A) and ending point (B)

While the disc is playing, press the LOOP and B buttons. The last cue point is set as point A, and seamless loop playback begins.

After setting point A, set the cue mode, press button A, then use the scan or search function to fine-adjust point A. (The same can be done for point B.)

(2) Leaving the seamless loop mode temporarily

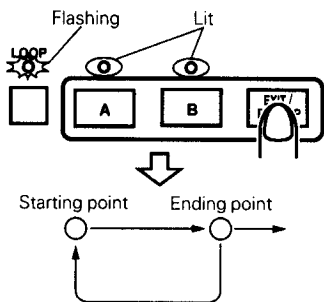

Figure 18

Press the EXIT/RELOOP button while playing a seamless loop. (The LOOP button's LED starts flashing.)

When the ending point (B) is reached, playback continues without returning to the starting point (A).

(3) Replaying a seamless loop

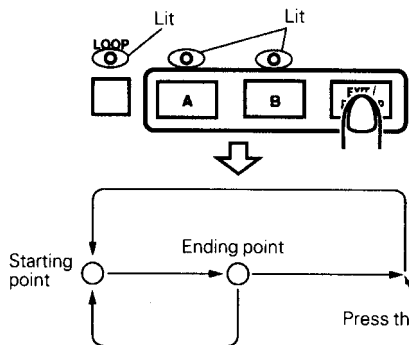

Figure 19

Press the EXIT/RELOOP button or button B during normal playback. (The LOOP button's LED stops flashing, remaining lit.) (The position at which button B is pressed is set as the new loop playback ending point (B)). Playback returns to the starting point (A) and seamless loop playback begins.

(4) Switching from seamless loop playback to normal disc playback

(Setting the normal playback mode without canceling the starting and ending points)

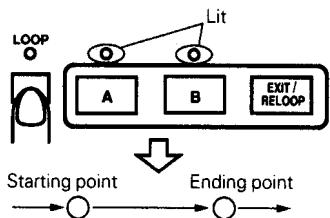

Figure 20

Press the LOOP button within 1 second. (The LOOP button's LED turns off.) The normal playback mode is set. (Only the loop mode is canceled. Points A and B are not cleared.)

NOTE:

The starting point (A) and ending point (B) settings are canceled when the disc is removed from the player.

(5) Canceling the seamless loop settings

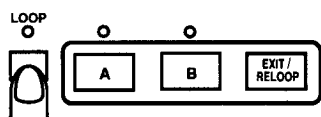

Figure 21

- Press the LOOP button for over 1 second.
(The LOOP button's LED turns off.)
When this is done, the starting point (A) and ending point (B) settings are automatically canceled.
(The A and B buttons' LEDs turn off.)

NOTE:

- After canceling the seamless loop during loop playback, it may take about 5 seconds before the seamless loop mode is set again.

6 SAMPLER

The DN-2500F is equipped with a function for recording the sound of a disc for up to 8 seconds on both players. In addition, the recorded sound can be played normally, in the reverse mode (backwards) and in a loop. These sampler functions eliminate the need for a separate sampler.

NOTE: The sampler mode cannot be used at the same time as the seamless loop mode.

(1) Recording samples

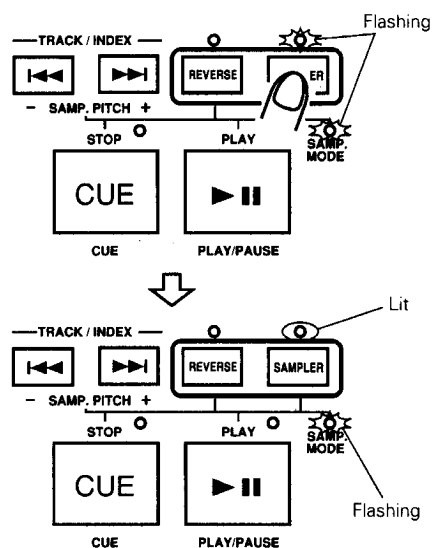

Figure 22

- Press the SAMPLER button.
(The SAMPLER button's LED and the SAMP. MODE LED start flashing.)
Recording starts.
- The sound is recorded for approximately 8 seconds.
(The SAMPLER button's LED stops flashing, remaining lit.)
Recording can also be stopped in less than 8 seconds by pressing the CUE button.
(The SAMPLER button's LED stops flashing, remaining lit.)

NOTE:

- When sample recording is set while the disc is playing, playback continues after recording stops.
When sample recording is set during in the cue, pause or manual search mode, disc playback stops when recording stops.

(2) Playing the sample

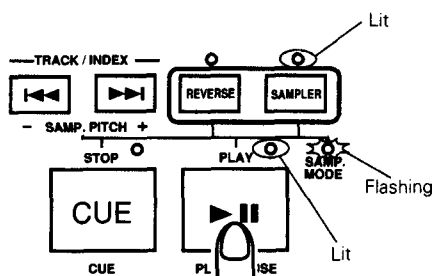

Figure 23

- Press the PLAY/PAUSE button.
(The PLAY/PAUSE button's LED lights.)
The sample is played.

(3) Stopping the sample

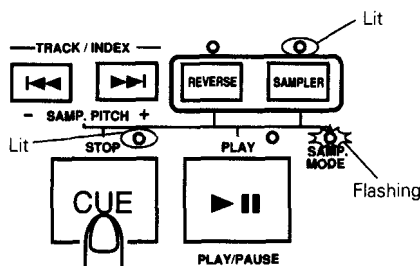

Figure 24

- Press the CUE button.
(The CUE button's LED lights.)
The sample is stopped.

(4) Changing the sample's pitch

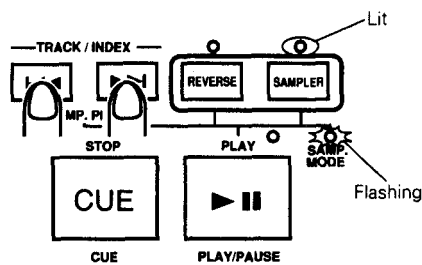

Figure 25

- Press the TRACK >>I button to increase the sample's playing speed, the TRACK I<< button to decrease it.
The sample playing speed changes in steps of 0.5% and the speed flashes on the PITCH display section for approximately 3 seconds.
(The sampler pitch range is ± 16%).

(5) Setting the normal disc playback mode after recording a sample

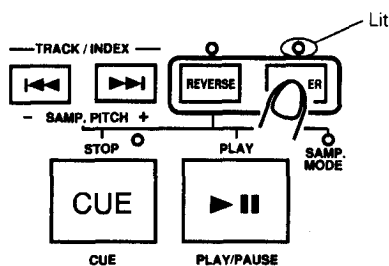

Figure 26

- After the sample has been recorded, press the SAMPLER button.
(The SAMP. MODE LED turns off.)
Normal disc playback is now possible.
The sample can be played again by pressing the SAMPLER button again.
(The SAMP. MODE LED flashes.)

NOTE:

- When the SAMP. MODE LED is flashing, the following buttons function as sampler buttons, so they cannot be used for their normal operations:
PLAY/ PAUSE, CUE, TRACK >>I, TRACK I<< (However, the TRACK >>I and I<< buttons can be preset to be used as the normal track selection buttons. ITEM No. 2)
- The recorded sample is not cleared when the disc is removed from the player.

(6) Playing the sample in reverse

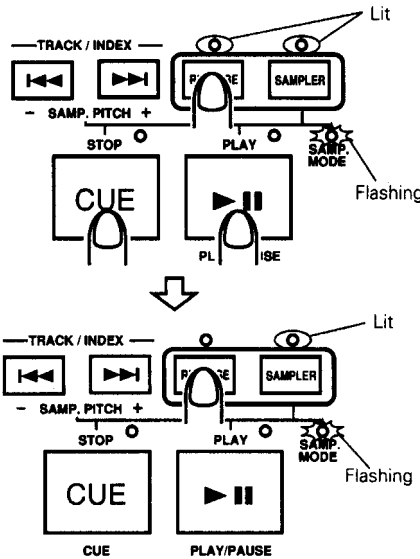

Figure 27

Press the REVERSE button.

(The REVERSE button's LED lights.)

Reverse playback begins from the recording end position when the PLAY/PAUSE button is pressed after pressing the REVERSE button.

Press the REVERSE button again.

(The REVERSE button's LED turns off.)

The reverse sample play mode is canceled.

Sampler normal playback begins when the PLAY/PAUSE button is pressed after pressing the REVERSE button.

(7) Playing the sample in a loop

This setting can be turned on and off with the presets. (ITEM No. 1)

(8) This clears the recorded sample

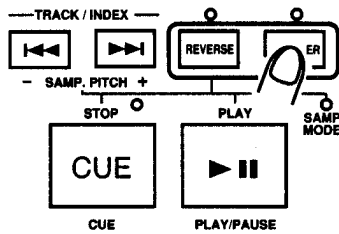

Figure 28

Press the SAMPLER button for over 1 second.

(The SAMPLER button's LED and the SAMP. MODE LED turn off.)

This clears the recorded sample.

7 KEY CONTROL

The DN-2500F is equipped with a function for adjusting the key of the sound being played.

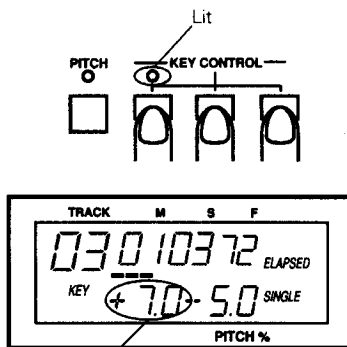

The display changes.

(continued on next page)

Press the KEY CONTROL button.

(The KEY CONTROL button's LED lit.)

(The current setting appears in the key section of the display.)

The key can be adjusted.

Press the KEY ▲ button to raise the key.

Press the KEY ▼ button to lower the key.

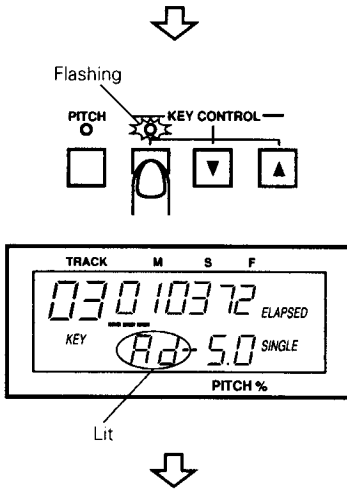

Figure 29

Press the KEY CONTROL button again.
 (The KEY CONTROL button's LED starts flashing.)
 (" Ad " appears in the key section of the display.)
 The key can be adjusted to the normal key even when the pitch (speed) is changed.

NOTE:
 The key adjustment range is ± 16.0 .

Press the KEY CONTROL button again.
 (The KEY CONTROL button's LED turns off.)
 The key control function is canceled.

8 VOICE REDUCER

The DN-2500F is equipped with a function to reduce the sound of the vocals in the music. This sound can be used as an effect sound for the sampler, etc.

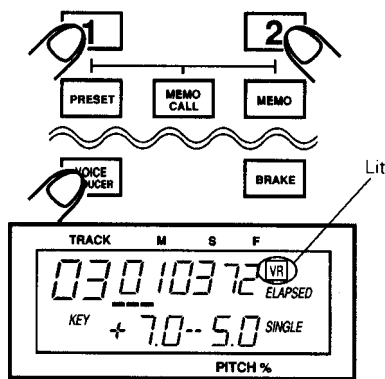

Figure 30

Press the CD1 (or CD2) button while pressing the VOICE REDUCER button.
 (" VR " appears in the voice reducer section of the display.)
 The voice reducer function is set.

Once again press the CD1 (or CD2) button while pressing the VOICE REDUCER button.
 (" VR " turns off from the voice reducer section of the display.)
 The voice reducer function is canceled.

NOTE: Depending on the original recording, the vocals may not be completely eliminated.
 This is even more effective when used with music in which the vocals are at the center.

9 BRAKE

The DN-2500F is equipped with a function for gradually slowing the playback speed before stopping. This sound can be used as an effect sound. (Playback stops in about 0.5 seconds.)

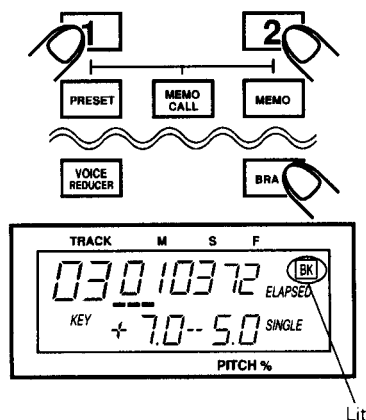

Figure 31

- 9 Press the CD 1 (or CD 2) button while pressing the BRAKE button. ("BK" appears in the brake section of the display.)
The brake function is set.
Braking is performed when the PLAY/PAUSE button is pressed during playback while the brake mode is on.

Once again press the CD 1 (or CD 2) button while pressing the BRAKE button.

("BK" turns off from the brake section of the display.)
The brake function is canceled.

10 CUSTOM SETTING MEMORY

The DN-2500F is equipped with a function for storing and calling out disc identification data, cue points, pitches, and seamless loop starting points (A) and ending points (B).

(1) Storing data in the memory

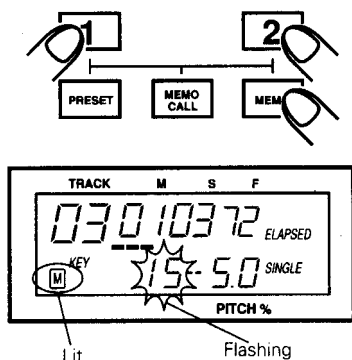

Figure 32

Cue up the player.

- Press the CD 1 (or CD 2) button while pressing the MEMO button. ("M" appears in the memory section of the display, and the memory number (0 to 199) flashes for approximately 3 seconds in the key section of the display.)

The above operation stores the following data in the memory:

- Disc identification data
- Cue point
- Current playback pitch (0.0% if the pitch mode is off)
- Seamless loop starting point (A) and ending point (B) (Only if set)

In addition, if data is mistakenly registered, use the procedure in "(4) Clearing data" to clear the data.

NOTE:

In the cases described below, there is no space left in the memory. If you attempt to store data in the memory "FL" appears and the data is not stored.

When there are already 200 sets of data stored in the memory
(The maximum storage capacity is 200 discs and 200 sets of data.)

When data for that track is already stored in the memory.
(Only one set of data can be stored per track.)

(2) Overwriting previous data

(This is only possible if 200 sets of data are already stored.)

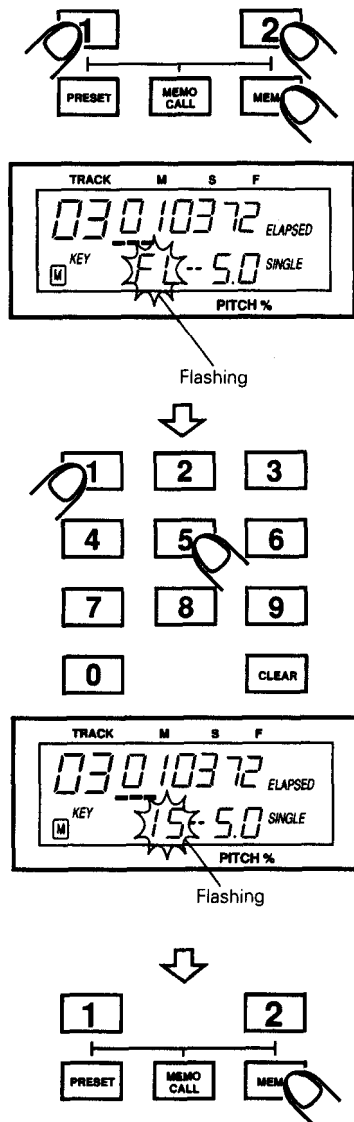

Press the CD 1 (or CD 2) button while pressing the MEMO button.
(" FL " flashes in the key section of the display.)

Use the number buttons to input the number of the memory to be over-written.
(The memory number flashes in the key section of the display.)

Press the MEMO button.
("M " appears in the memory section of the display.)
The data is now overwritten.

Figure 33

(3) Recalling data

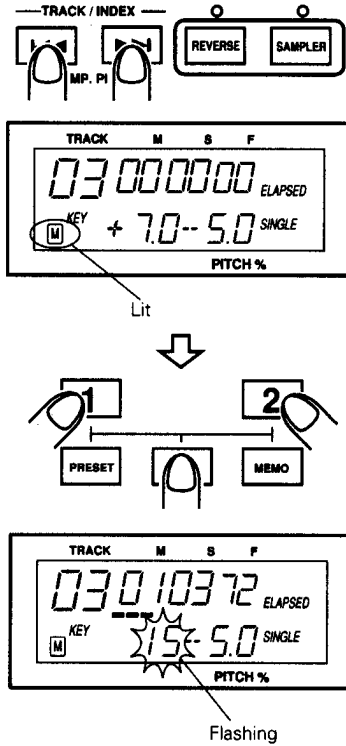

Figure 34

When a custom setting memory disc is set in the player, the **[M]** indicator flashes, indicating that there is a memory.

Use the TRACK >>| and |<< buttons to select the track whose data you want to recall.

("M" appears in the memory section of the display after the track is selected.)

Press the CD 1 (or CD 2) button while pressing the MEMO CALL button. (The memory number (0 to 199) of the recalled data flashes for approximately 3 seconds in the key section of the display.)

The data is recalled and the pickup moves to the cue point stored in the memory.

(The CUE button's LED lights. If seamless loop data is stored, the LOOP, A and B button's LEDs also light.)

In addition, the playback pitch is fixed to the registered playback pitch.

(The pitch LED flashes.)

NOTE: The track starting position changes through audio detection, so the time display of the called out cue point, A point and B point may be different from when the points were stored in the memory.

(4) Clearing data

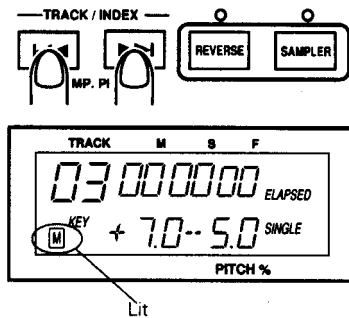

(continued on next page)

Use the TRACK >>| and |<< buttons to select the track whose data you want to clear.

("M" appears in the memory section of the display after the track is selected.)

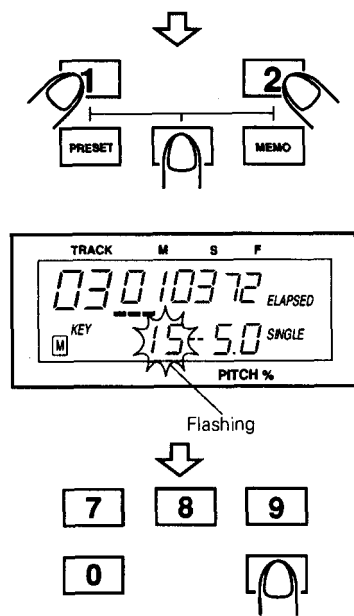

Figure 35

Press the CD 1 (or CD 2) button while pressing the MEMO CALL button.

Press the CLEAR button during the 3 seconds that the memory number (0 to 199) of the recalled data is flashing in the key section of the display. (The memory number and the "M" turn off from the key and memory sections of the display.) The data is now cleared.

NOTE: Even when the data is cleared, the memory remains called out.

11 DIRECT SEARCH

The DN-2500F is equipped with a function for directly accessing a specific position on the disc or a specific index number using the number buttons and the CUE and PLAY/PAUSE buttons.

(1) Direct track and time search

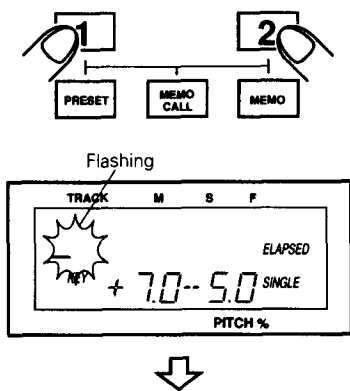

(continued on next page)

Press the CD 1 (or CD 2) button.
 (" - "flashes in the track section of the display and the time section turns off.)

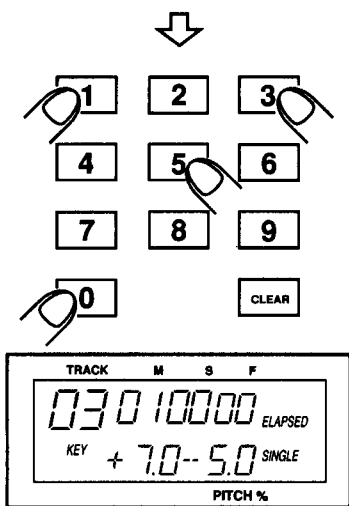

Figure 36

Use the number buttons to input the track, minutes, seconds and frame.
(If the input data does not exist on the disc, the input value flashes on the display and no other data can be input.)

There is no need to input the minute, second and frame data.

Press the PLAY/PAUSE button.

Playback begins from the specified position.

(If the CUE button is pressed, the pickup moves to the specified position.)

The direct search mode is canceled when the CD 1 (or CD 2) button is pressed.

When inputting direct search data [ELAPSED] is displayed.

(2) **Direct index search**

Set the index mode, then use the same procedure as for direct track and time search to directly access the specified index number.

12 PRESETTINGS

The DN-2500F is equipped with a function for storing various types of preset data. This data is not lost when the power is turned off. Use this function to store in the memory the desired settings for the items described on the table on Page 29. The presettings can be made independently for CD 1 and CD 2. Use this function to operate the players with the optimum settings.

(1) **Changing the preset data**

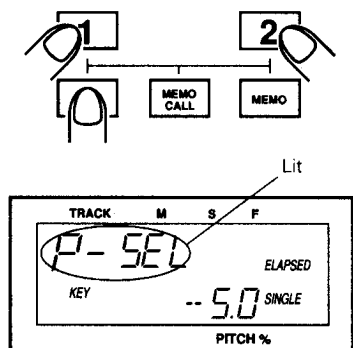

Press the CD 1 (or CD 2) button while pressing the PRESET button.
(“ P-SEL ” appears in the track and time sections of the display, and the key section turns off.)

NOTE: The preset item can also be changed during disc playback.

(continued on next page)

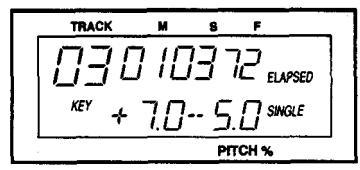
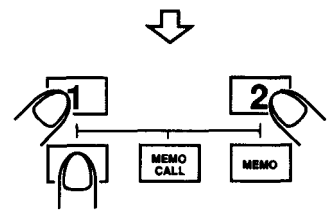
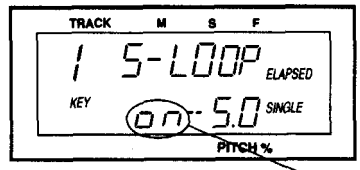
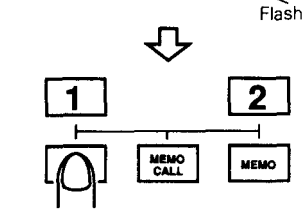
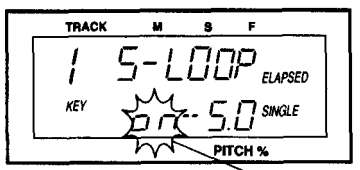
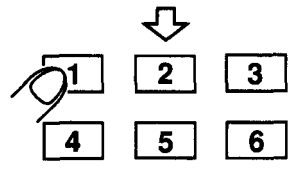
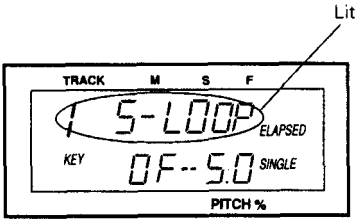
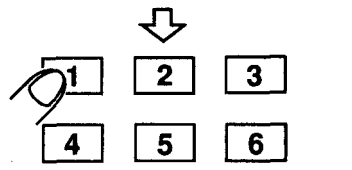

Figure 37

Use the number buttons to input the number of the preset item.
 (The preset item number appears in the track and time sections of the display, and the preset data appears in the key section.)

To select the preset data, press and hold in the number button corresponding to the preset item number.
 (The preset data in the key section of the display changes and flashes.)

- 9 After selecting the preset data, press the PRESET button to set the new data.
 (The preset data in the key section of the display stops flashing, remaining lit.)
 Repeat the same procedure to change the data of other preset items.

Press the CD 1 (or CD 2) button while pressing the PRESET button or the CD 1 (or CD 2) to exit the preset mode.
 (The track, time and key sections of the display switch to their normal displays.)
 The preset data is now changed.
 Preset data changing can also be exited by pressing the PLAY/PAUSE, CUE or OPEN/CLOSE button.

(2) Table of Preset Functions

" " indicates factory settings

Item no.	Item	Display (" " indicates a space)		Description
		Track / time	Key	
1	Sampler loop setting	1 S-LOOP	on OF	ON: Loop playback with sampler. OFF: * No loop playback with sampler.
2	Pitch change setting during sample playback	25 SPEED	on OF	ON: * Pitch changed with sampler. OFF: No pitch change with sampler. When this is set, the track can be selected with the TRACK buttons.
3	Pitch adjustment range setting	3 Pitch	4.0 8.0 16.0	4%: Pitch can be increased or decreased within a range of ± 4%. (0.1% step) 8%: * Pitch can be increased or decreased within a range of ± 8%. (0.1% step) 16%: Pitch can be increased or decreased within a range of (0.2% step) ± 16%.
4	Cue detection level setting	4 AutoCue	L n H OF	-72dB Cueing is performed not at the actual starting point of the track but at the point where the sound starts. The level for detecting the first sound can be set to between -36dB and -72dB. -60dB* -36dB OFF Cue detection off
5	EOM time setting	5 End	0 10 15 20 30 60 90	0sec * EOM OFF 10sec 15sec 20sec 30sec 60sec 90sec When the end of the track approaches, the LCD display starts flashing, visually warning the operator that the track is about to end. The time at which the display starts flashing can be set to between 10 and 60 seconds from the end of the track. NOTE: For some discs the EOM time may not be accurate.
6	Disc holder auto close setting	6 CLOSE	on OF	ON: The disc holder closes automatically after it is left open for approximately 1 minute. OFF: * The disc holder does not close automatically.
7	Setting of initial playback mode when power is turned on	7 InCont	S, Co	Single: * Playback ends at the end of one track. Continue: Playback continues through to the end of the disc.
8	Setting of initial time display mode when power is turned on	8 ELAP RE	EL RE	Elapse: * The elapsed time is displayed when the power is turned on. Remain: The remaining time is displayed when the power is turned on.
9	Servo auto stop setting	9 SLEEP	on OF	ON: The servo stops automatically. OFF: * The servo does not stop automatically. Servo auto stop: If no button is pressed for approximately 30 minutes in the pause or cue up modes, the servo stops and "SLEEP" is displayed. ● Press the CUE button to switch from the servo stop mode to the normal mode.
0	Custom Setting Memory all clear setting	0 ALL CLR	on OF	ON: All the memory data is cleared. OFF: * Not all the custom setting memory is cleared. The setting returns to OFF after all the data is cleared.
CLEAR	Reset to factory settings	PS-CL	on OF	ON: Sets the preset data to the factory settings. OFF: * Leaves the preset data unchanged.

13 FADER INPUT

Fader playback is possible by connecting a console fader to the fader input plug.



Figure 38

Playback starts when the switch is turned on.
The pause mode is set when the switch is turned off.
(FADER INPUT LEVEL HCMOS (Ii = -3mA))

14 BEFORE SWITCHING OFF THE POWER

When you have finished using the CD player, before switching off the power, be sure that the disc holder has been closed with the OPEN/CLOSE button.

CAUTION:

Do not forcibly close the disc holder when the power is off.
It may damage the unit when it is transported.

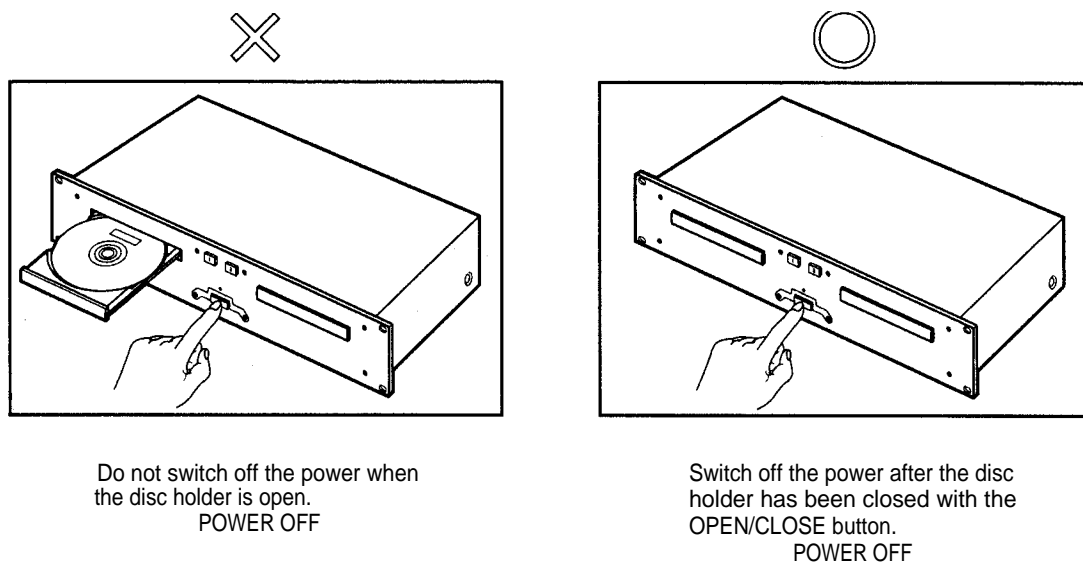

Figure 39

COMPACT DISCS

1. Precautions on handling compact discs

Do not allow fingerprints, oil or dust to get on the surface of the disc.

If the disc is dirty, wipe it off with a soft dry cloth.

We recommend using DENON's AMC-22 CD CLEANER.

Do not use benzene, thinner, water, record spray, electrostatic-proof chemicals, or silicone-treated cloths to clean discs.

Always handle discs carefully to prevent damaging the surface; in particular when removing a disc from its case or returning it.

Do not bend the disc.

Do not apply heat.

Do not enlarge the hole in the center of the disc.

Do not write on the label (printed side) with a hard-tipped implement such as a pencil or ball point pen.

Condensation will form if a disc is brought into a warm area from a colder one, such as outdoors in winter. Do not attempt to dry the disc with a hair dryer, etc.

2. Precaution on storage

After playing a disc, always unload it from the player. Always store the disc in the jewel case to protect from dirt or damage.

Do not place discs in the following areas:

- 1) Areas exposed to direct sunlight for a considerable time.
- 2) Areas subject to accumulation of dust or high humidity.
- 3) Areas affected by heat from indoor heaters, etc.

16 SPECIFICATIONS**GENERAL**

Type:	Twin mechanism compact disc player with wired controller		
Disc type:	Standard compact discs (12 cm and 8 cm discs)		
Dimensions:	Player unit:	482 (W) x 88(H) x 252 (D) mm (without feet)	
		19" (W) x 3-15/32 (H) x 9-59/64 (D)	
Installation:	Control unit:	482 (W) x 132(H) x 40 (D) mm (without feet)	
		19" (W) x 5-13/64 (H) x 1-37/64 (D)	
Weight:	19-inch rack mountable		
	Player unit:	2U	
Power supply:	Control unit:	3U	
	Player unit:	6 kg (13.23 lbs.)	
Power consumption:	Control unit:	3 kg (6.614 lbs.)	
	U.S. and Canadian models:	120 V AC	± 10%, 60 Hz
Environmental conditions:	European models:	230 V AC	± 10%, 50 Hz
	27 W		
Accessories:	Operational temperature:	5 to 35°C	(41 to 95°F)
	Operational humidity:	25 to 85%	(no condensation)
	Storage temperature:	-20 to 60°C	(4 to 140°F)
	Connecting cord (2 pairs for left and right channels)		
	Control cord (5m, 15 feet)		

AUDIO SECTION

Quantization:	18-bit linear per channel
Sampling frequency:	44.1 kHz at normal pitch
Oversampling rate:	8 times
Frequency response:	20 to 20,000 Hz
Total harmonic distortion:	0.006%
Signal to noise, ratio:	98 dB
Dynamic range:	98 dB
Channel separation:	96 dB
Output level:	2.0 V
Load impedance:	10 kΩ/kohms or more

FUNCTIONS

Instant start:	Within 10 msec.	
Variable pitch:	4% range:	± 4% or more
	8% range:	± 8% or more
	16% range:	± 16% or more
	4% and 8% ranges:	± 12% or more
Pitch bend:	16% range:	± 18% or more
	8.19 sec.	
Sampling length:	Over 20 times normal speed	
Max. scan speed:	200 steps	

* Specifications and design are subject to change without notice for purpose of improvement.